

BASO 2.5

DIRECT/INDIRECT



Catalog Number Example

BASO 2.5-PDT-BL-OPBW-30K-C80-UNV-010V-SEN-455LF-NLC-ST-96IN

A RANGE

BASO 2.5 BASO2.5

B MOUNTING

Pendant P D T

Pendant in-line ACT T-BAR P A T

Pendant in-line ACT SLOT P A S

Pendant ACT center tile P A C

pendant suspension set includes cable suspension and one white power feeder with a white junction box cover

Wall mounted W A L

for black power feeds or junction box covers, please contact customer service

C COLOR

QS White W H

QS Black B L

Gray G R

Custom color RAL X X

trimless version available in white only

D LENS

HP opal cover direct O P B W

batwing cover indirect

E CCT

2700K 2 7 K

QS 3000K 3 0 K

QS 3500K 3 5 K

4000K 4 0 K

F CRI

CRI > 80 C 8 0

CRI > 90 C 9 0

G VOLTAGE

120V / 277V U N V

H DIMMING

QS 0-10V 1% 0 1 0 V

Lutron EcoSystem L E S 1

Quantum, Vive, GRAFIK Eye, HomeWorks

Power over ethernet P O E C

consult customer service for compatibility

Custom dimming X X X X

consult customer service for compatibility

I SENSOR (optional)

Integrated Sensor S E N

consult customer service for sensor request

J OUTPUT LM/FT DOWN

QS 500lm/ft 100% ↓ 0 5 0 0 L F

QS 750lm/ft 100% ↓ 0 7 5 0 L F

QS 1000lm/ft 100% ↓ 1 0 0 0 L F

Custom lm/ft X X X X L F

custom lumen up to 1200 lm/ft

K OUTPUT LM/FT UP

QS 500lm/ft ↑ 0 5 0 0 L F

QS 750lm/ft ↑ 0 7 5 0 L F

QS 1000lm/ft ↑ 1 0 0 0 L F

Custom lm/ft X X X X L F

custom lumen up to 1000 lm/ft

K CIRCUIT / EM

QS Single circuit *

EMC night light circuit N L C

EMB available in 4ft and 8ft E M #

Dual Circuit D C

*leave blank

L SHAPE / PATTERN

QS Linear / straight S T

Linear / straight + flex inset S F

includes 4ft. field-cutttable section

L-shape L S

□-shape (rectangular shape) R S

U-shape U S

Custom shape X X

M DIMENSIONS IN INCH

QS Linear 4' 4 8 I N

QS Linear 6' 7 2 I N

QS Linear 8' 9 6 I N

Linear custom # # # I N

Linear flex inset # # # I N

includes 4' to 3' field-cutttable section

L-Shape # # # X # # # I N

U-Shape # # # X # # # X # # # I N

□-Shape # # # X # # # I N

for curved options, please see our SHAPES brochure

for lengths including flex insets, round up to the nearest total foot length

N CERTIFICATION (optional)

Red List Approved D R L A

PERFORMANCE

- Up to 112lm/W efficiency
- 455 / 750lm/ft
- CRI > 80 & CRI > 90
- Damp rated

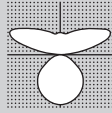

MOUNTING

Wall

Pendant

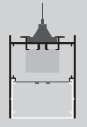
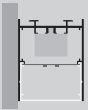

PATTERNS



*X Shapes



Angles



Curves



Rectangles



*T Shapes



*Wall to Ceiling

For customization, please contact customer service

FIELD-CUTTABLE FLEX

Down to 1/16"



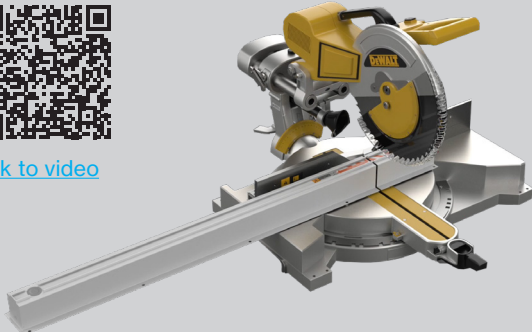

[link to video](#)



BASO
basolighting.com
xalusa.com

Technical data

	SIZE TYPE	LED COLOR TEMPERATURE	INPUT WATTS	DELIVERED LM TOTAL	LIGHT DISTRIBUTION	DELIVERED LM DIRECT	DELIVERED LM INDIRECT	OPTICAL EFFICIENCY	LUMINAIRE EFFICACY
BASO DIRECT / INDIRECT									
	e LED	4' linear	16.4 W	1820 lm	40% down / 60% up	188 lm/ft	270 lm/ft	72%	111 lm/W
		8' linear	32.8 W	3650 lm					
		2' + 2' corner	16.4 W	1820 lm					
	e ² LED	4' linear	26.8 W	3020 lm	40% down / 60% up	312 lm/ft	445 lm/ft	72%	112 lm/W
		8' linear	53.5 W	6040 lm					
		2' + 2' corner	26.8 W	3020 lm					

for 30 K or 35 K multiply lm value by 0.96

Patterns top view

LINEAR

A	FIXTURES	CODE
48"	1 × 4' linear	ST - 0 4 FT
96"	1 × 8' linear	ST - 0 8 FT
144"	3 × 4' linear	ST - 1 2 FT



L-SHAPE

A / B	FIXTURES	CODE
48" / 48"	2 × 2' linear + 1 × 2' × 2' corner	LS - 0 4 X 0 4 FT
48" / 96"	1 × 2' linear + 1 × 6' linear + 1 × 2' × 2' corner	LS - 0 4 X 0 8 FT
96" / 96"	2 × 6' linear + 1 × 2' × 2' corner	LS - 0 8 X 0 8 FT

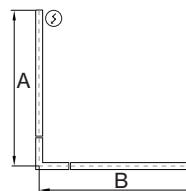

□-SHAPE (rectangular shape)

A / B	FIXTURES	CODE
48" / 48"	4 × 2' × 2' corner	RS - 0 4 X 0 4 FT
48" / 96"	2 × 4' linear + 4 × 2' × 2' corner	RS - 0 4 X 0 8 FT
96" / 96"	4 × 4' linear + 4 × 2' × 2' corner	RS - 0 8 X 0 8 FT

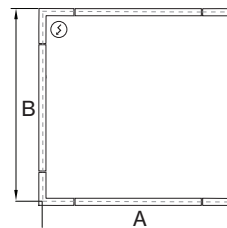

U-SHAPE

A / B / C	FIXTURES	CODE
48" / 48" / 48"	2 × 2' linear + 2 × 2' × 2' corner	US - 0 4 X 0 4 X 0 4 FT
48" / 96" / 48"	1 × 4' linear + 2 × 2' linear + 2 × 2' × 2' corner	US - 0 4 X 0 8 X 0 4 FT
48" / 144" / 48"	1 × 8' linear + 2 × 2' linear + 2 × 2' × 2' corner	US - 0 4 X 1 2 X 0 4 FT

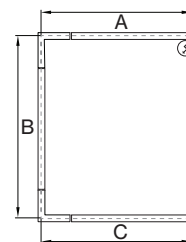

DIMENSIONS

BASO 2.5

PENDANT

direct

direct / indirect

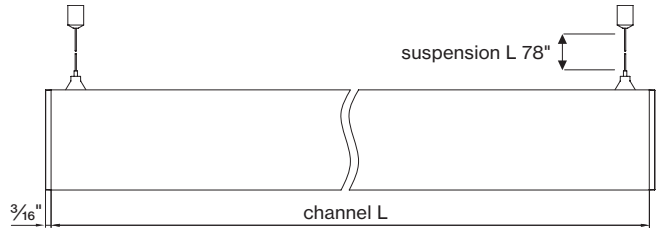
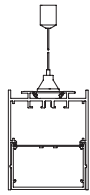
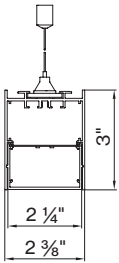

BASO 2.5 SPECIALITY MOUNTING

SURFACE
in-line ACT TBAR

SURFACE
in-line ACT SLOT

SURFACE
ACT center tile

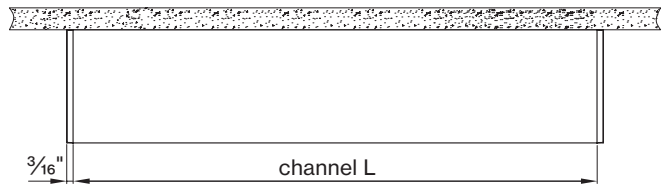
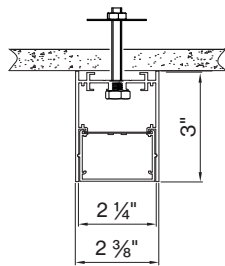
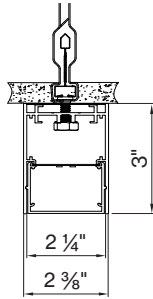
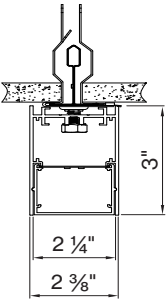

PENDANT
ACT TBAR

PENDANT
in-line ACT SLOT

PENDANT
ACT center tile

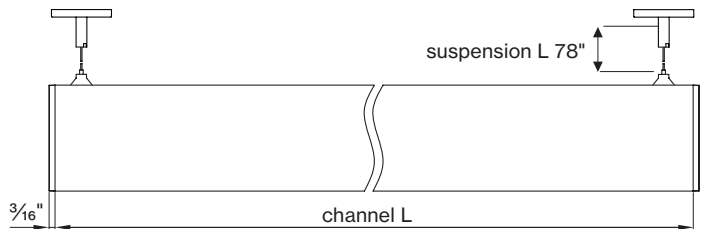
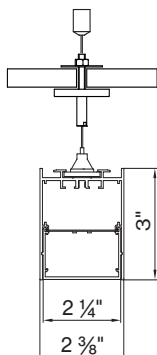
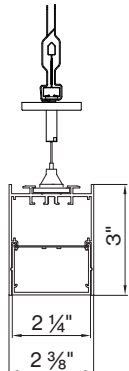
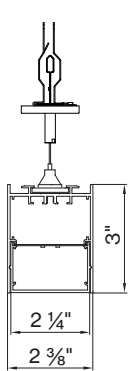

Declare.

BASO 1.5 2.5 4.0
XAL USA Incorporated
Final Assembly: Collins, Connecticut, USA
LBC (Declare's brand)
End of Life Options: Recyclable (70%), Landfill (30%)

Ingredients:
Aluminum, 2-Phenylacetic acid, 2-methyl-, methyl ester, polymer with ethyl 2-cyanobutylate, steel, manufacture, chemical, copper chloride (CuCl₂), Polyvinyl Chloride, Unmethylated Silica, Polypropylene, Polyethylene, Polyethylene Glycol, Polyethylene Glycol, Copper Iron, Tin, Organic Silicones, Zinc

LBC Temp Exception: RECOG - Small Electrical Components

Living Building Challenge Criteria:

HB Red List:
LBC Red List Free: **Y** Disposed 100% at 100ppm
LBC Red List Approved: VOC Content: Not Applicable
Fluorinated:

HB Interior Performance: Not Applicable
HB Responsible Sourcing: Not Applicable

XAL-0002
E011 01 MAR 2024
Original Issue Date: 2023

INTERNATIONAL LIVING FUTURE INITIATIVE | www.livingfuture.com

BASO mounting instructions

Get access to the BASO 2.5 mounting instructions faster by scanning the QR code.

www.xalusa.com/resources/mounting-instructions/baso

